

--

Date:
Client:
Project:

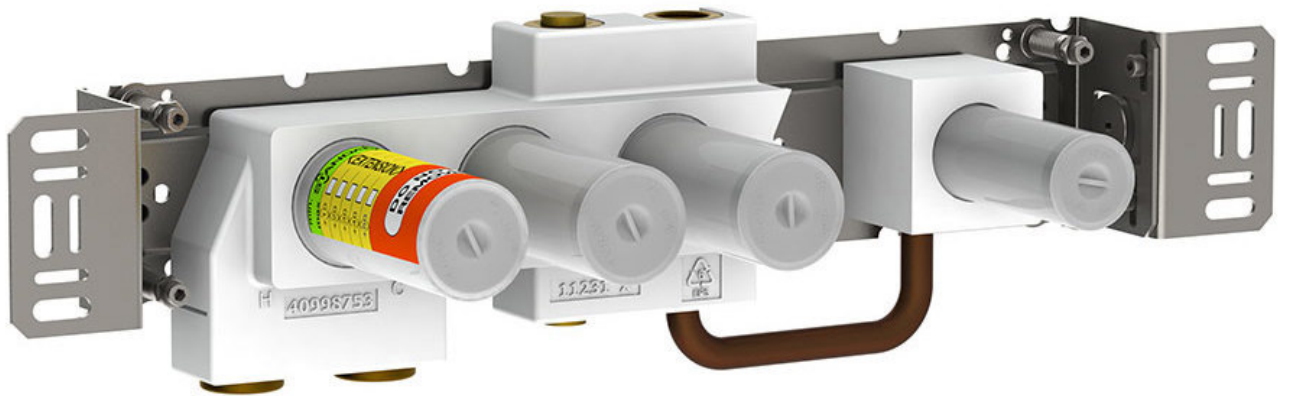

5400F

Thermostatic mixer with diverter, fixed outlet socket and one separate outlet socket, 200M. 3/4" connection to copper, steel, iron or pex pipe work.

Flow

	Bar:	1.0	2.0	3.0	4.0	5.0
Outlet 1	(l/min)	18.5	26.1	32.0	37.0	41.3
Outlet 2	(l/min)	18.5	26.1	32.0	37.0	41.3
Cal Outlet 1	(l/min)	4.0	5.7	7.0	7.0	7.0
Cal Outlet 2	(l/min)	4.0	5.7	7.0	7.0	7.0

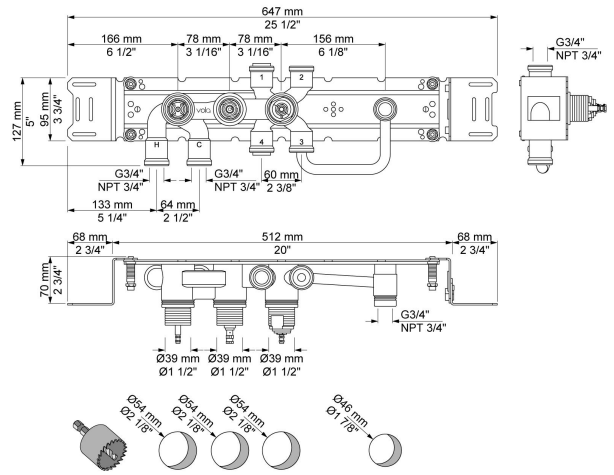

Available in colors



200M

Separate outlet socket.

1/2" connection to copper, steel, iron or pex pipe work.

