

VOLA 100, 100X, 200, 200V, 300
 VOLA 400DV, 400, 400V, 400N, 400NV, 400T
 VOLA 400TV, 400F, 400FV, 400R, 400RV
 VOLA 2100, 2100X, 2200, 2200V, 2300, 2400
 VOLA 2400V, 2400N, 2400NV, 2400T, 2400TV
 VOLA 2400F, 2400FV, 2400R, 2400RV



Fitting instruction Monteringsvægledning
 Montageanleitung Montage hanleiding
 Monteringsvejledning Manuel de montage



04/00029
 04/00031
 04/00055



www.vola.com

100-2100_V3_40998502
 11-07-2024

vola



5 705230 286211

	L	L1	L2	H	H1	D
100, 100X, 200V, 300, 400V, 400DV 2100, 2100X, 2200V, 2300, 2400V	377 mm 14 3/4"	260 mm 10"	268 mm 10 1/2"	95 mm 3 3/4"	186 mm 7 3/8"	70 mm 2 3/4"
400NV, 400TV 2400NV, 2400TV	475 mm 18 3/4"	355 mm 14"	367 mm 14 1/2"			
400FV, 400RV 2400FV, 2400RV	552 mm 21 3/4"	435 mm 17"	447 mm 17 5/8"			



VR968: To be ordered separately.
 Werden separat bestellt.
 Bestilles separat.
 Beställs separat.
 Apart te bestellen.
 À commander séparément.

A Data, 3 Bar/43.5 Psi:

	l/min.	Gal/min.	Max. 65°C, 150°F
100:	18,3	4.8	Max.: 10 Bar/145 psi
400V:	15,6	4.1	
2100:	25,2	6.7	
2400V:	22,2	5.9	

B Check the local legislation.
 Bitte die örtlichen Vorschriften überprüfen.
 Tjek de lokale regler.
 Kontrollera den lokala lagstiftning.
 Verifieer de lokale regelgeving.
 Vérifiez la législation locale.



C DE: Bitte separat beiliegende Anleitung für die Schalldämpfer VR1249 beachten

DE: Bitte separat beiliegende Anleitung für die Schallentkopplung VR972 beachten



T	Y	VR1260/2260/1400/1020K
3 - 15 mm	110 - 98 mm	Std.
15 - 25 mm	98 - 88 mm	+10
25 - 35 mm	88 - 78 mm	+20
35 - 45 mm	78 - 68 mm	+30
45 - 55 mm	68 - 58 mm	+40
55 - 65 mm	58 - 48 mm	+50

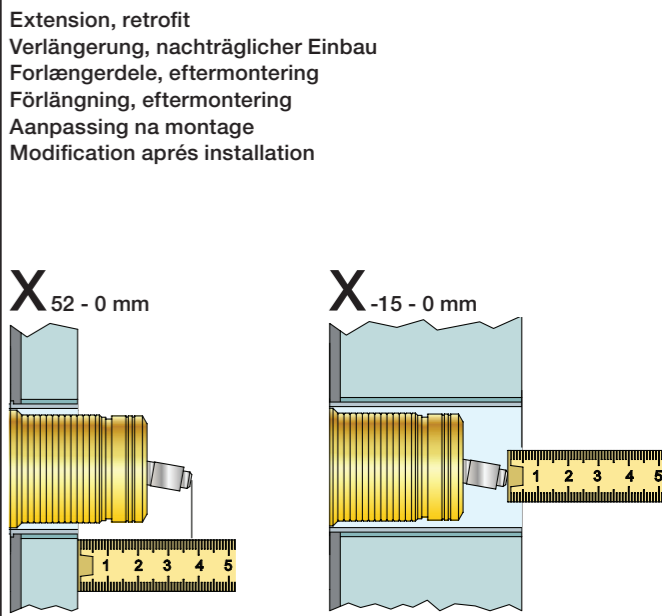

X	VR1260 + VR1400 + VR1020K
40 - 52 mm	Std.
30 - 40 mm	+10
20 - 30 mm	+20
10 - 20 mm	+30
0 - 10 mm	+40
-10 - 0 mm	+50

X	VR2260 + VR1400 + VR1020K
35 - 47 mm	Std.
25 - 35 mm	+10
15 - 25 mm	+20
5 - 15 mm	+30
-5 - 5 mm	+40
-15 - -5 mm	+50

Fitting of extension Monterings av förlängning
 Montage von verlängerung Montage van de verlengstukken
 Monterings af forlængerdele Montage des rallonges





2x13 mm Lightweight wall
 Leichtwand
 Let væg

Lätta konstruktion
 Holle wandconstructie
 Construction légère



1x15 mm
1x18 mm
1x20 mm

2x13 mm

Lightweight wall
 Leichtwand
 Let væg

Lätta konstruktion
 Holle wandconstructie
 Construction légère



Masonry
 Mauerwerk
 Murværk

Murverk
 Massieve wand
 Mur Plein



2 Test Pressure
 Prüfdruck
 testtryk
 Test tryk
 Test druk

Check the local legislation.
 Bitte die örtlichen Vorschriften überprüfen.
 Tjek de lokale regler.
 Kontrollera den lokala lagstiftning.
 Verifieer de lokale regelgeving.
 Vérifiez la législation locale.

1. MAX. 16 Bar 232 Psi

2. MAX. 4 Bar 58 Psi

! Water - Wasser - Vand - Vatten - Water - L'eau
! MAX 1 Minute - Minut - Minuut !



VOLA 010, 020, 030, 040
VOLA 010C, 020C, 040D

Fitting instruction
 Montageanleitung
 Monteringsvejledning
 Monteringsvægledning
 Montage hanleiding
 Manuel de montage



04/00026
 04/00101
 04/00175
 04/00298



www.vola.com
 mnt_010_V1_40998360
 23-05-2023



Standard Flow data:		Max.
010/020	(l/min)	5.0
	(Gal/min)	1.3
010C/020C	(l/min)	30
	(Gal/min)	7.9
030	(l/min)	9.0
	(Gal/min)	2.0
040	(l/min)	25
	(Gal/min)	6.6
040D	(l/min)	30
	(Gal/min)	7.9
		Max. 65°C. Max. 150°F



VR161:
 VR161K: 7 l/min - 1.8 Gal/min
 VR161D: 9 l/min - 2.5 Gal/min
 VR161F: 14 l/min - 3.7 Gal/min



For more water saving possibilities please see:
 Weitere Wassersparmöglichkeiten finden Sie auf:
 For flere vandbesparende muligheder se venligst:
 För mer vattenbesparande möjligheter hänvisas till:
 Voor meer waterbesparende mogelijkheden zie:
 Pour plus d'informations sur les options : économie d'eau, voir le site:

www.vola.com



010, 020



010C, 020C



	L (mm)	L (Inch)
010(C)/100	100	4"
010(C)/130	130	5"
010(C)/160	160	6"
020(C)/200	200	7 3/4"
020(C)/225	225	8 3/4"
020(C)/260	260	10 1/4"
020(C)/300	300	11 3/4"

030



	L (mm)	L (Inch)
030/200	200	7 3/4"
030/250	250	9 3/4"
030/300	300	11 3/4"
030/350	350	13 3/4"

040



040D



	L (mm)	L (Inch)
040	185	7 3/4"
040D	200	7 3/4"
040D/250	250	9 3/4"
040D/300	300	11 3/4"

1

010, 010C, 020, 020C, 030, 040, 040D

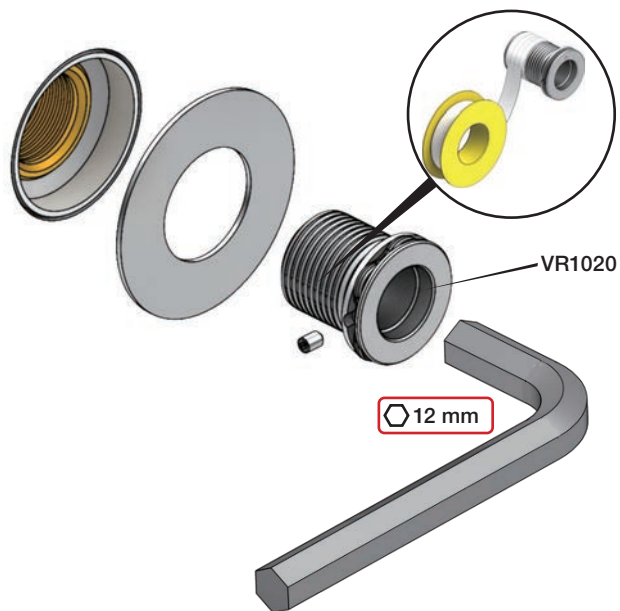

VR1020

12 mm

2



3

Ø19: 010, 020, 030, 040



VR1019 - Ø19

2.0 mm

Ø24: 010C, 020C, 040D

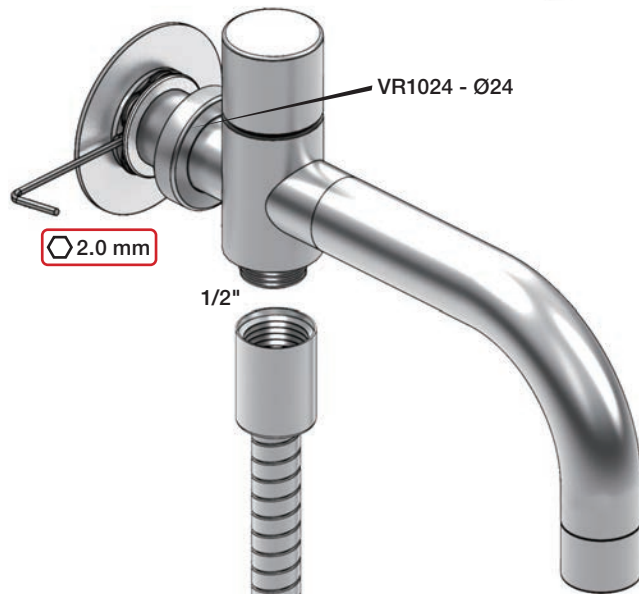

VR1024 - Ø24

2.0 mm

1/2"

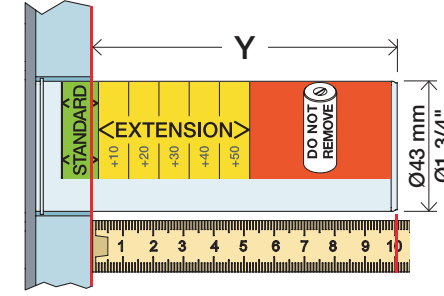
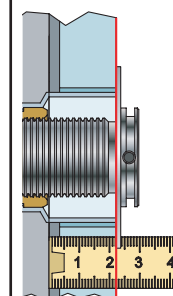
Extension
VerlängerungForlængerdele
FörlängningVerlengstukken
ModificationT
Min. 3 mm
Max. 65 mmY
Min. 48 mm
Max. 110 mm

T	Y	VR1020K	VR2019 (Ø19) VR2119 (Ø24)
3 - 15 mm	110 - 98 mm		Std.
15 - 25 mm	98 - 88 mm		+10
25 - 35 mm	88 - 78 mm		+20
35 - 45 mm	78 - 68 mm		+30
45 - 55 mm	68 - 58 mm		+40
55 - 65 mm	58 - 48 mm		+50

VR1020K+ / VR2019+ / VR2219+

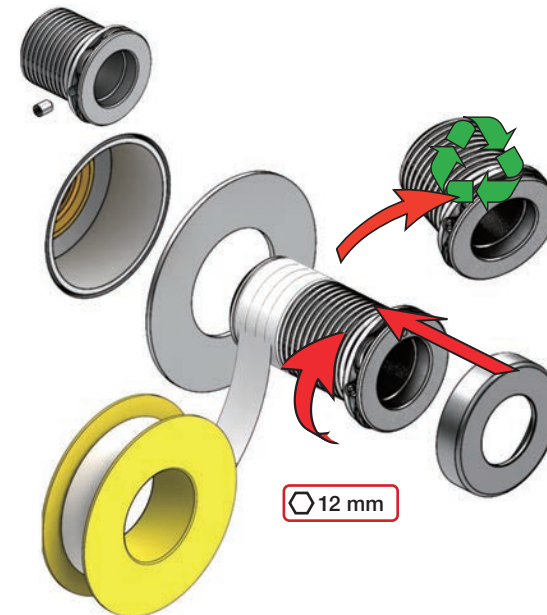

12 mm

Do not cut the membrane
 Die Membran nicht schneiden
 Skær ikke membranen
 * Skär inte membranet
 Snij het membraan niet door
 Ne coupez pas la membrane
 No cortar la membrana

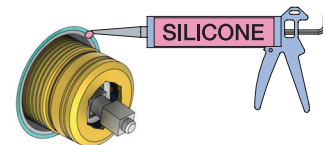

*Membran används inte i SVERIGE,
 ihop med inbyggnadsboxen.

NR.21:

1

NR.28+19+24:

2

Förlängning
 Verlängerung
 Extension
 Anpassing
 Modifikation
 Fortlængelse

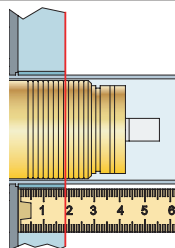

VR2260/VR1400/VR2019		
	3 - 15 mm	Std.
Tiles:	15 - 25 mm	+10
Fliesen:	25 - 35 mm	+20
Fliser:	35 - 45 mm	+30
Tegels:	45 - 55 mm	+40
Carreaux:	55 - 65 mm	+50

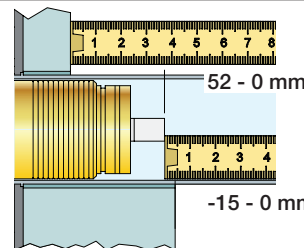

VR2260/VR1400/VR2019		
	35 - 47 mm	Std.
	25 - 35 mm	+10
	15 - 25 mm	+20
	5 - 15 mm	+30
	-5 - 5 mm	+40
	-15 - 5 mm	+50

NR 21



NR 21 - 1

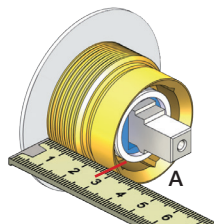

		A
VR2279	16 mm	30 - 34 mm
VR2279B	12 mm	26 - 30 mm
VR2279C	8 mm	22 - 26 mm

NR 21 - 2

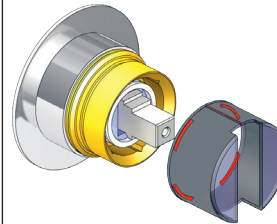

NR 21 - 3

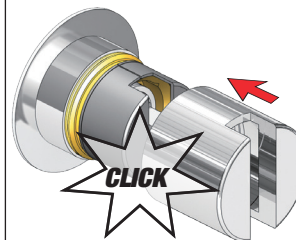

NR 21 - 4

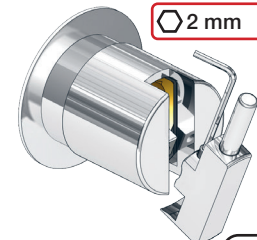



VR1260/VR1400/VR2019		
Tegeles: Carreaux:	3 - 15 mm	Std.
	15 - 25 mm	+10
	25 - 35 mm	+20
	35 - 45 mm	+30
Tiles: Fliesen: Fliser:	45 - 55 mm	+40
	55 - 65 mm	+50



VR1260/VR1400/VR2019		
40 - 52 mm	Std.	
30 - 40 mm	+10	
20 - 30 mm	+20	
10 - 20 mm	+30	
0 - 10 mm	+40	
-10 - 0 mm	+50	

NR 19/NR24

NR 19:
 Ø40 mm
 Ø1 5/8"

NR 24:
 Ø43 mm
 Ø1 3/4"



NR 28 - 1

VR3279 VR3279B VR3279C

	A	
VR3279	16 mm	31 - 36 mm
VR3279B	12 mm	27 - 32 mm
VR3279C	8 mm	23 - 28 mm



NR 19 - 1
NR 24 - 1

VR2204 VR2204B VR2204C

NR 19 - VR665

	A	
VR665	16 mm	ALL
VR2204	16 mm	16 - 21 mm
VR2204B	12 mm	11 - 17 mm
VR2204C	8 mm	7 - 13 mm





NR21: VR20D, VR22, VR1275, VR2269, VR2273, VR2278, VR2279, VR2279B, VR2279C
 VR1277K: VR22, VR1277, VR2269

<p>2100</p> <p>2927</p>	<p>2100X</p> <p>2927</p>	<p>2200V</p> <p>2928</p>	<p>2300</p> <p>2927</p>
<p>2002</p>	<p>2003KB</p>	<p>2003B</p>	<p>2002</p>
<p>2001, 001</p>	<p>2001, 001</p>	<p>2001</p>	<p>2001, 001</p>



vola
 Lunavej 2
 DK-8700 Horsens
 Tlf : + 45 7023 5500
 sales@vola.com
 www.vola.com

VOLA 2100
 2100X, 2200V, 2300

Date
 May. 22

Rev.
 4

Sheet
 SB 10.7

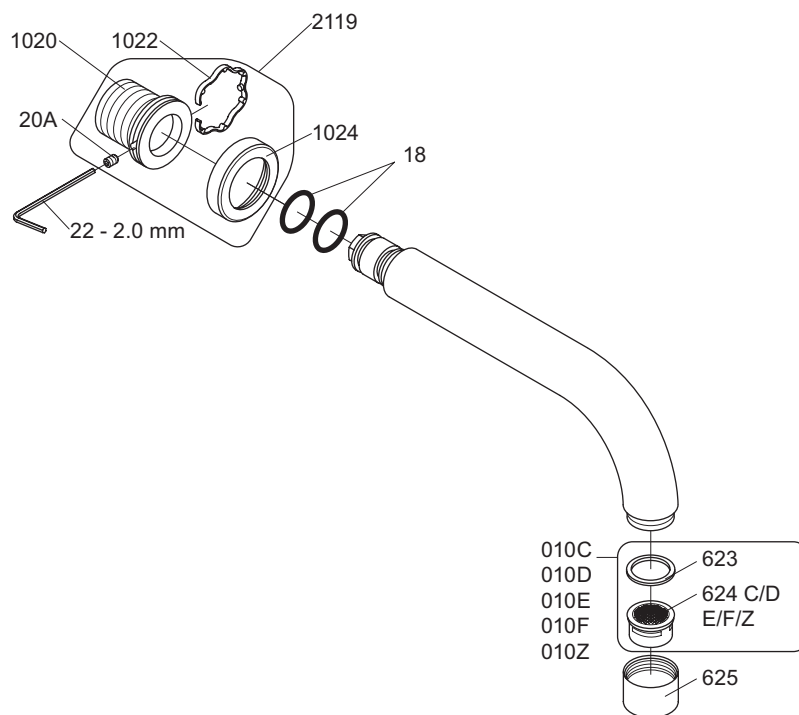

VR010C: VR623, VR624C
 VR010D: VR623, VR624D
 VR010E: VR623, VR624E
 VR010F: VR623, VR624F
 VR010Z: VR623, VR624Z
 VR1020K: VR20A, VR22, VR1020, VR1022
 VR2119: VR20A, VR22, VR1020, VR1022, VR1024

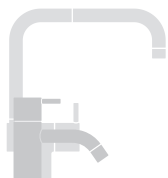

volapart

Lunavej 2
 DK-8700 Horsens
 Tlf : + 45 7023 5500
 sales@volapart.com
 www.volapart.com

VOLA 010C/020C

Date
Apr. 21

Rev.
2

Sheet
SB 11.1